









Diagonal Corner Wall Cabinet Assembly Instruction

(Item:WDC2412)

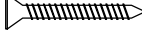
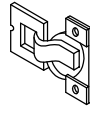
Hardware list	1 4pcs $\varnothing 4 \times 16\text{mm}$ Flat head screw	2 2pcs $\varnothing 4 \times 19\text{mm}$ Round head screw	3 8pcs $\varnothing 3.5 \times 14\text{mm}$ Color galvanized screw with flat head	4 32pcs $\varnothing 3.5 \times 16\text{mm}$ Color galvanized screw with flat head	5 10pcs $\varnothing 3.5 \times 35\text{mm}$ Black screw with flat head	6 2pcs 1-1/4" Hinge	7 6mm Shelf clips	
								
Assembly tools required	Screw driver	Rubber mallet	11 4pcs 40mmx40mm Bracket rainbow 135°		10 4pcs 40mmx40mm Bracket rainbow 90°		9 2pcs $\varnothing 7$ Bumper	8 2set L-shape bracket
								
Cabinet Part List	A Front frame	B Small side panels(2)	C Top&Bottom panel	D Big side panels(2)	E Back panel	F Door		

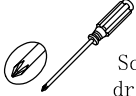
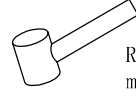
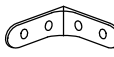
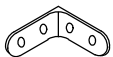
Step 1 : With front frame (A) of cabinet lay down on clean and soft surface then put glue into groove.

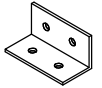
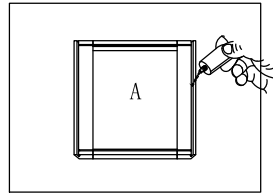

Step 2 : Install small side panels. Insert two small side panels (B) into groove of front frame (A) until side panel (B) and front frame (A) even.

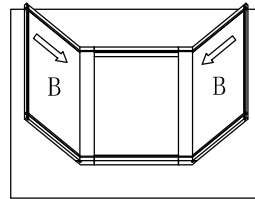

Step 3 : Install top and bottom panel. Insert top and bottom panel (C) into groove of side panel (B) until it into the groove of front frame (A).

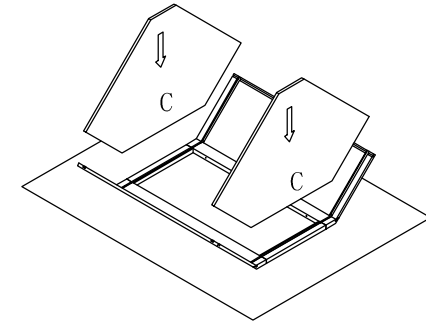

Step 4 : Install big side panels. Insert big side panel (D) into groove of both small side panels (B) until top&bottom panels insert into groove of big side panel.

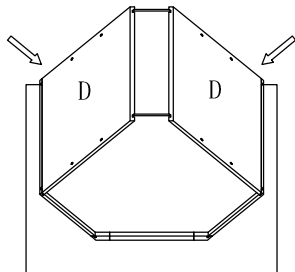

Step 5 : Install the back panel.

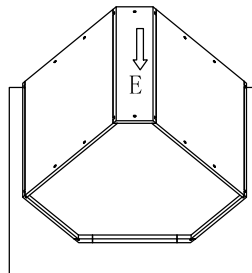

Step 6 : Screw the big side panels and top&bottom panel, also screw the back panel and top&bottom panel.

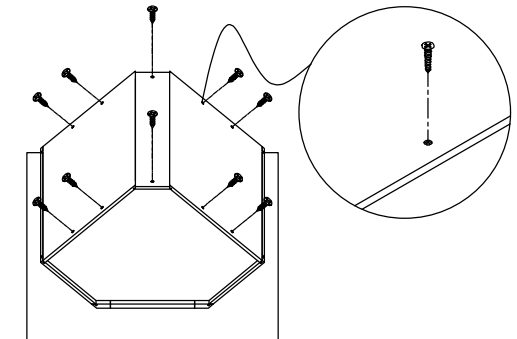

Diagonal Corner Wall Cabinet Assembly Instruction

(Item:WDC2412)

Step 7 : Install rainbow bracket. Screw the rainbow bracket to the side panel(B) and front frame(A) and also screw the L-shape bracket to the front frame(A) and top panel(C), the same as the other hand .

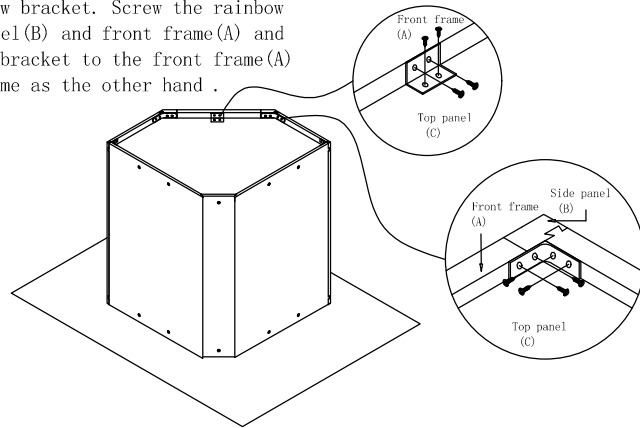

Step 8 : Install door. Screw the hinge to the door (F) and front frame (A).

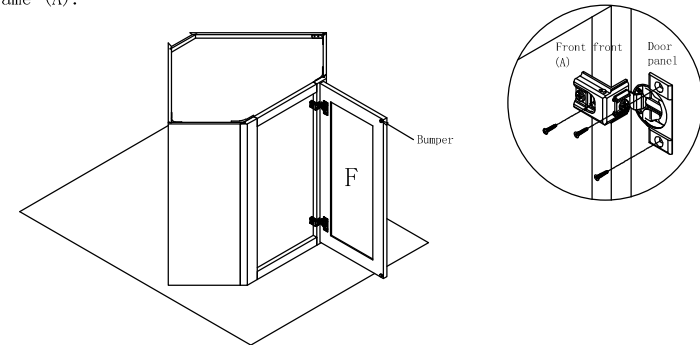

Step 9 : Finish installation of cabinet.

